

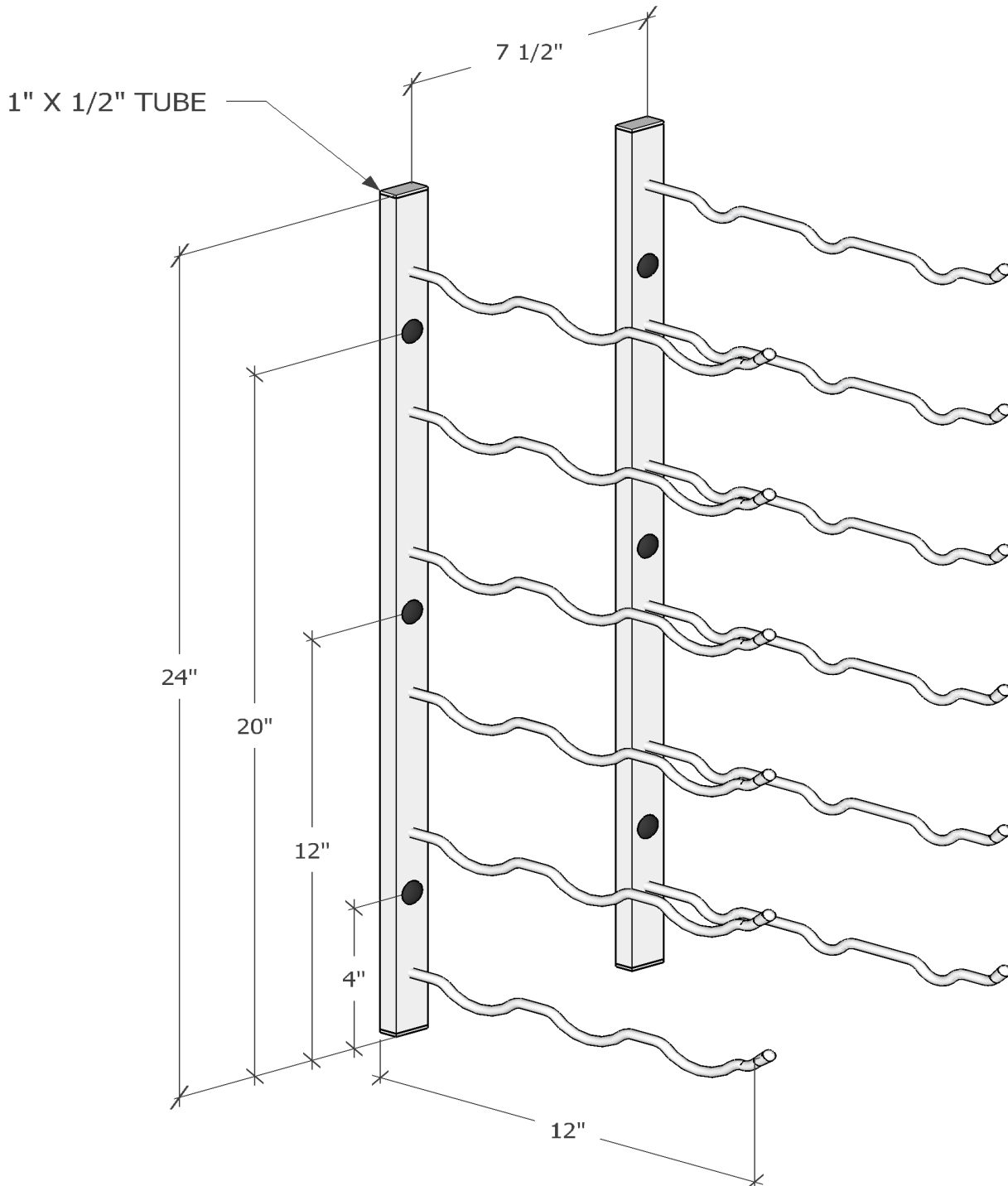

VINTAGEVIEW®
MOVING WINE STORAGE FORWARD

Wine Master Cellars, LLLP • 10645 E 47th Ave, Denver, CO 80239 • phone: 866.650.1500 • fax: 866.650.1501 • VintageView.com

Wall Series 2 foot 3 bottle deep (WS23) Spec Sheet



VintageView recommends 13 inches overall width allowance for most wine bottles.

For product warranty information, please visit: VintageView.com/support/warranty
We're here to help, call us at 866-650-1500 with any questions.